

Two-position selector switches

Non-illuminated

Modular range



How to order:

Order: Operator + holder + contact block(s)
or operator + holder with contact block(s)

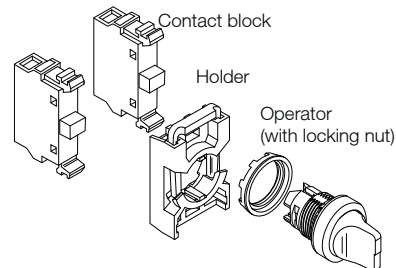

Bezel options



Description	How to order	Type	Order Code
Black plastic	Standard	M2SSX-10X	1SFA61120X R100X
Chrome plastic	Replace '1' with '2' in Type and Order Code	M2SSX-20X	1SFA61120X R200X
Chrome metal	Replace '1' with '3' in Type and Order Code	M2SSX-30X	1SFA61120X R300X

Operator for non-illuminated two-position selector switch

Description	Color	Packing qty: 1 pc		Weight, kg
		Type	Order Code	

Short handle

Maintained



- Red
- Black
- Grey

M2SS1-10R	1SFA 611 200 R1001
M2SS1-10B	1SFA 611 200 R1006
M2SS1-10U	1SFA 611 200 R1007

0.015
0.015
0.015

Maintained



- Red
- Black
- Grey

M2SS2-10R	1SFA 611 201 R1001
M2SS2-10B	1SFA 611 201 R1006
M2SS2-10U	1SFA 611 201 R1007

0.015
0.015
0.015

Momentary, spring return from C to B



- Red
- Black
- Grey

M2SS3-10R	1SFA 611 202 R1001
M2SS3-10B	1SFA 611 202 R1006
M2SS3-10U	1SFA 611 202 R1007

0.015
0.015
0.015

Long handle

Maintained



- Red
- Black
- Grey

M2SS4-10R	1SFA 611 203 R1001
M2SS4-10B	1SFA 611 203 R1006
M2SS4-10U	1SFA 611 203 R1007

0.018
0.018
0.018

Maintained



- Red
- Black
- Grey

M2SS5-10R	1SFA 611 204 R1001
M2SS5-10B	1SFA 611 204 R1006
M2SS5-10U	1SFA 611 204 R1007

0.018
0.018
0.018

Momentary, spring return from C to B



- Red
- Black
- Grey

M2SS6-10R	1SFA 611 205 R1001
M2SS6-10B	1SFA 611 205 R1006
M2SS6-10U	1SFA 611 205 R1007

0.018
0.018
0.018

Contact blocks and holder

See the fold-out page at the end of the catalog.

Contacts actuated

Two position selector switch

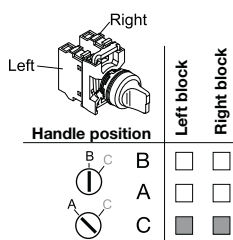

- Not actuated
- Actuated

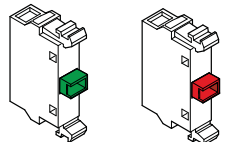

NO 3-4 NC 1-2

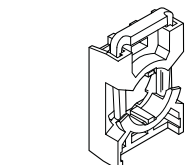



Three-position selector switches

Non-illuminated

Modular range

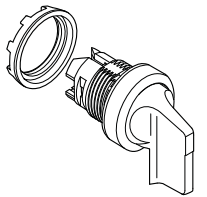
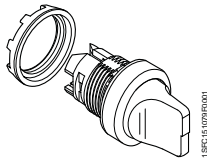
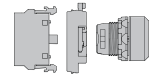

Contacts actuated

Three position selector switch

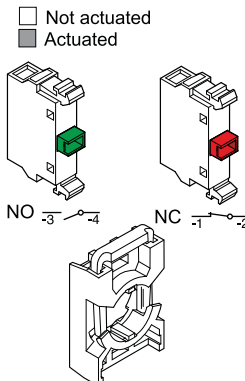
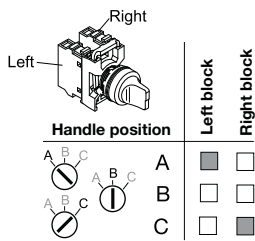

Bezel options

Description	How to order	Type	Order Code
Black plastic	Standard	M3SSX-10X	1SFA61121X R100X
Chrome plastic	Replace '1' with '2' in Type and Order Code	M3SSX-20X	1SFA61121X R200X
Chrome metal	Replace '1' with '3' in Type and Order Code	M3SSX-30X	1SFA61121X R300X

Operator for non-illuminated three-position selector switch

Description	Color	Packing qty: 1 pc		Weight, kg
		Type	Order Code	

Operator with black bezel and short handle

Maintained

	● Red	M3SS1-10R	1SFA 611 210 R1001	0.015
	● Black	M3SS1-10B	1SFA 611 210 R1006	0.015
	● Grey	M3SS1-10U	1SFA 611 210 R1007	0.015

Momentary, spring return from A to B and from C to B

	● Red	M3SS2-10R	1SFA 611 211 R1001	0.015
	● Black	M3SS2-10B	1SFA 611 211 R1006	0.015
	● Grey	M3SS2-10U	1SFA 611 211 R1007	0.015

Momentary, spring return from C to B

	● Red	M3SS3-10R	1SFA 611 212 R1001	0.015
	● Black	M3SS3-10B	1SFA 611 212 R1006	0.015
	● Grey	M3SS3-10U	1SFA 611 212 R1007	0.015

Momentary, spring return from A to B

	● Red	M3SS7-10R	1SFA 611 216 R1001	0.015
	● Black	M3SS7-10B	1SFA 611 216 R1006	0.015
	● Grey	M3SS7-10U	1SFA 611 216 R1007	0.015

Long handle

Maintained

	● Red	M3SS4-10R	1SFA 611 213 R1001	0.018
	● Black	M3SS4-10B	1SFA 611 213 R1006	0.018
	● Grey	M3SS4-10U	1SFA 611 213 R1007	0.018

Momentary, spring return from A to B and from C to B

	● Red	M3SS5-10R	1SFA 611 214 R1001	0.018
	● Black	M3SS5-10B	1SFA 611 214 R1006	0.018
	● Grey	M3SS5-10U	1SFA 611 214 R1007	0.018

Momentary, spring return from C to B

	● Red	M3SS6-10R	1SFA 611 215 R1001	0.018
	● Black	M3SS6-10B	1SFA 611 215 R1006	0.018
	● Grey	M3SS6-10U	1SFA 611 215 R1007	0.018

Momentary, spring return from A to B

	● Red	M3SS8-10R	1SFA 611 217 R1001	0.018
	● Black	M3SS8-10B	1SFA 611 217 R1006	0.018
	● Grey	M3SS8-10U	1SFA 611 217 R1007	0.018

Contact blocks and holder

See the fold-out page at the end of the catalog.



Three-position selector switches

With operation of center position
Non-illuminated

Modular range

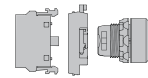

How to order:

Order: Operator + holder + contact block(s)
or operator + holder with contact block(s)

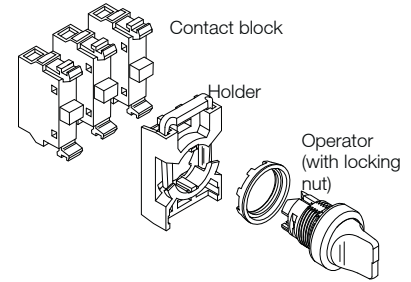

Bezel options

Description	How to order	Type	Order Code
Black plastic	Standard	M3SSCX-10X	1SFA61125X R100X
Chrome metal	Replace '1' with '3' in Type and Order Code	M3SSCX-30X	1SFA61125X R300X

Operator for three-position selector switch with operation of center position

Description	Color	Bezel	Packing qty: 1 pc		Weight, kg
			Type	Order Code	

Short handle

	● Black	Black plastic	M3SSC1-10B	1SFA 611 250 R1006	0.015
	● Black	Chrome metal	M3SSC1-30B	1SFA 611 250 R3006	0.024
	● Black	Black plastic	M3SSC2-10B	1SFA 611 251 R1006	0.015
	● Black	Chrome metal	M3SSC2-30B	1SFA 611 251 R3006	0.024
	● Black	Black plastic	M3SSC3-10B	1SFA 611 252 R1006	0.015
	● Black	Chrome metal	M3SSC3-30B	1SFA 611 252 R3006	0.024
	● Black	Black plastic	M3SSC7-10B	1SFA 611 256 R1006	0.015
	● Black	Chrome metal	M3SSC7-30B	1SFA 611 256 R3006	0.024

Long handle

	● Black	Black plastic	M3SSC4-10B	1SFA 611 253 R1006	0.018
	● Black	Chrome metal	M3SSC4-30B	1SFA 611 253 R3006	0.027
	● Black	Black plastic	M3SSC5-10B	1SFA 611 254 R1006	0.018
	● Black	Chrome metal	M3SSC5-30B	1SFA 611 254 R3006	0.027
	● Black	Black plastic	M3SSC6-10B	1SFA 611 255 R1006	0.018
	● Black	Chrome metal	M3SSC6-30B	1SFA 611 255 R3006	0.027
	● Black	Black plastic	M3SSC8-10B	1SFA 611 257 R1006	0.018
	● Black	Chrome metal	M3SSC8-30B	1SFA 611 257 R3006	0.027

Contact blocks and holder

See the fold-out page at the end of the catalog.

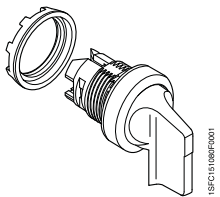
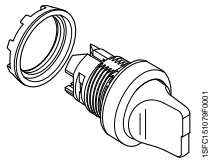

Contacts actuated

Three position selector switch with operation of center position

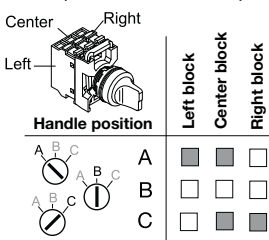

□ Not actuated
■ Actuated

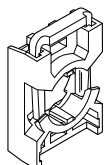
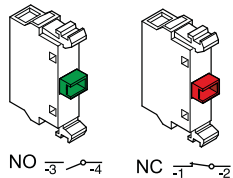



Two-position selector switches

Illuminated

Modular range

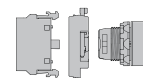

How to order:

Order: Operator + holder + contact blocks + lamp block
or operator + holder with contact blocks and lamp block

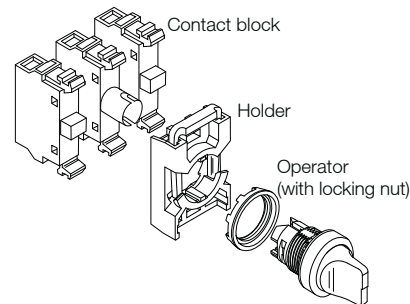

Bezel options



Description	How to order	Type	Order Code
Black plastic	Standard	M2SSX-11X	1SFA61120X R110X
Chrome plastic	Replace '1' with '2' in Type and Order Code	M2SSX-21X	1SFA61120X R210X
Chrome metal	Replace '1' with '3' in Type and Order Code	M2SSX-310X	1SFA61120X R310X

Operator for illuminated two-position selector switch

Description	Color	Packing qty: 1 pc		Weight, kg
		Type	Order Code	

Short handle Bulb max 2 W, not included.

Maintained



- Red
- Green
- Yellow
- Blue
- Clear

M2SS1-11R	1SFA 611 200 R1101	0.015
M2SS1-11G	1SFA 611 200 R1102	0.015
M2SS1-11Y	1SFA 611 200 R1103	0.015
M2SS1-11L	1SFA 611 200 R1104	0.015
M2SS1-11C	1SFA 611 200 R1108	0.015

Maintained



- Red
- Green
- Yellow
- Blue
- Clear

M2SS2-11R	1SFA 611 201 R1101	0.015
M2SS2-11G	1SFA 611 201 R1102	0.015
M2SS2-11Y	1SFA 611 201 R1103	0.015
M2SS2-11L	1SFA 611 201 R1104	0.015
M2SS2-11C	1SFA 611 201 R1108	0.015

Momentary, spring return from C to B



- Red
- Green
- Yellow
- Blue
- Clear

M2SS3-11R	1SFA 611 202 R1101	0.015
M2SS3-11G	1SFA 611 202 R1102	0.015
M2SS3-11Y	1SFA 611 202 R1103	0.015
M2SS3-11L	1SFA 611 202 R1104	0.015
M2SS3-11C	1SFA 611 202 R1108	0.015

Long handle Bulb max 2 W, not included.

Maintained



- Red
- Green
- Yellow
- Blue
- Clear

M2SS4-11R	1SFA 611 203 R1101	0.018
M2SS4-11G	1SFA 611 203 R1102	0.018
M2SS4-11Y	1SFA 611 203 R1103	0.018
M2SS4-11L	1SFA 611 203 R1104	0.018
M2SS4-11C	1SFA 611 203 R1108	0.018

Maintained



- Red
- Green
- Yellow
- Blue
- Clear

M2SS5-11R	1SFA 611 204 R1101	0.018
M2SS5-11G	1SFA 611 204 R1102	0.018
M2SS5-11Y	1SFA 611 204 R1103	0.018
M2SS5-11L	1SFA 611 204 R1104	0.018
M2SS5-11C	1SFA 611 204 R1108	0.018

Momentary, spring return from C to B



- Red
- Green
- Yellow
- Blue
- Clear

M2SS6-11R	1SFA 611 205 R1101	0.018
M2SS6-11G	1SFA 611 205 R1102	0.018
M2SS6-11Y	1SFA 611 205 R1103	0.018
M2SS6-11L	1SFA 611 205 R1104	0.018
M2SS6-11C	1SFA 611 205 R1108	0.018

Contact blocks, holder and lamp block

See the fold-out page at the end of the catalog.

Contact functions See Page 20



Three-position selector switches

Illuminated

Modular range

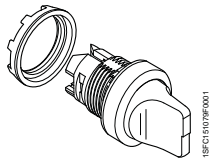
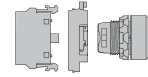

1SFA61121X R110X

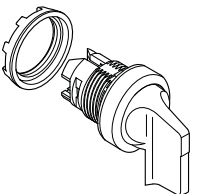

1SFA61121X R110X

Contacts actuated

Three position selector switch

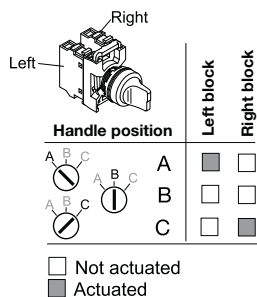

Contact blocks, holder and lamp block

See the fold-out page at the end of the catalog.

Ordering example See Page 23

Bezel options

Description	How to order	Type	Order Code
Black plastic	Standard	M3SSX-11X	1SFA61121X R110X
Chrome plastic	Replace '1' with '2' in Type and Order Code	M3SSX-21X	1SFA61121X R210X
Chrome metal	Replace '1' with '3' in Type and Order Code	M3SSX-310X	1SFA61121X R310X

Operator for illuminated three-position selector switch

Description	Color	Packing qty: 1 pc		Weight, kg
		Type	Order Code	

Short handle Bulb max 2 W, not included.

Maintained

Diagram	Color	Type	Order Code	Weight, kg
	Red	M3SS1-11R	1SFA 611 210 R1101	0.015
	Green	M3SS1-11G	1SFA 611 210 R1102	0.015
	Yellow	M3SS1-11Y	1SFA 611 210 R1103	0.015
	Blue	M3SS1-11L	1SFA 611 210 R1104	0.015
	Clear	M3SS1-11C	1SFA 611 210 R1108	0.015

Momentary, spring return from A to B and from C to B

Diagram	Color	Type	Order Code	Weight, kg
	Red	M3SS2-11R	1SFA 611 211 R1101	0.015
	Green	M3SS2-11G	1SFA 611 211 R1102	0.015
	Yellow	M3SS2-11Y	1SFA 611 211 R1103	0.015
	Blue	M3SS2-11L	1SFA 611 211 R1104	0.015
	Clear	M3SS2-11C	1SFA 611 211 R1108	0.015

Momentary, spring return from C to B

Diagram	Color	Type	Order Code	Weight, kg
	Red	M3SS3-11R	1SFA 611 212 R1101	0.015
	Green	M3SS3-11G	1SFA 611 212 R1102	0.015
	Yellow	M3SS3-11Y	1SFA 611 212 R1103	0.015
	Blue	M3SS3-11L	1SFA 611 212 R1104	0.015
	Clear	M3SS3-11C	1SFA 611 212 R1108	0.015

Momentary, spring return from A to B

Diagram	Color	Type	Order Code	Weight, kg
	Red	M3SS7-11R	1SFA 611 216 R1101	0.015
	Green	M3SS7-11G	1SFA 611 216 R1102	0.015
	Yellow	M3SS7-11Y	1SFA 611 216 R1103	0.015
	Blue	M3SS7-11L	1SFA 611 216 R1104	0.015
	Clear	M3SS7-11C	1SFA 611 216 R1108	0.015

Long handle Bulb max 2 W, not included.

Maintained

Diagram	Color	Type	Order Code	Weight, kg
	Red	M3SS4-11R	1SFA 611 213 R1101	0.018
	Green	M3SS4-11G	1SFA 611 213 R1102	0.018
	Yellow	M3SS4-11Y	1SFA 611 213 R1103	0.018
	Blue	M3SS4-11L	1SFA 611 213 R1104	0.018
	Clear	M3SS4-11C	1SFA 611 213 R1108	0.018

Momentary, spring return from A to B and from C to B

Diagram	Color	Type	Order Code	Weight, kg
	Red	M3SS5-11R	1SFA 611 214 R1101	0.018
	Green	M3SS5-11G	1SFA 611 214 R1102	0.018
	Yellow	M3SS5-11Y	1SFA 611 214 R1103	0.018
	Blue	M3SS5-11L	1SFA 611 214 R1104	0.018
	Clear	M3SS5-11C	1SFA 611 214 R1108	0.018

Momentary, spring return from C to B

Diagram	Color	Type	Order Code	Weight, kg
	Red	M3SS6-11R	1SFA 611 215 R1101	0.018
	Green	M3SS6-11G	1SFA 611 215 R1102	0.018
	Yellow	M3SS6-11Y	1SFA 611 215 R1103	0.018
	Blue	M3SS6-11L	1SFA 611 215 R1104	0.018
	Clear	M3SS6-11C	1SFA 611 215 R1108	0.018

Momentary, spring return from A to B

Diagram	Color	Type	Order Code	Weight, kg
	Red	M3SS8-11R	1SFA 611 217 R1101	0.018
	Green	M3SS8-11G	1SFA 611 217 R1102	0.018
	Yellow	M3SS8-11Y	1SFA 611 217 R1103	0.018
	Blue	M3SS8-11L	1SFA 611 217 R1104	0.018
	Clear	M3SS8-11C	1SFA 611 217 R1108	0.018



Key-operated selector switches

Two and three positions

Modular range

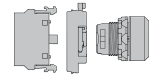

How to order:

Order: Operator + holder + contact blocks
or operator + holder with contact blocks

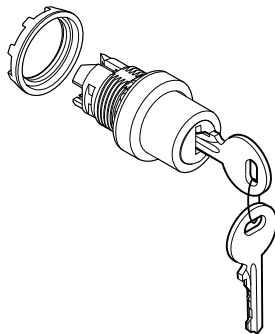
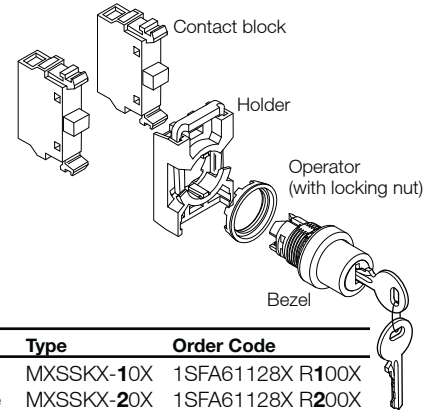

Contacts actuated

Two position key-operated selector switch

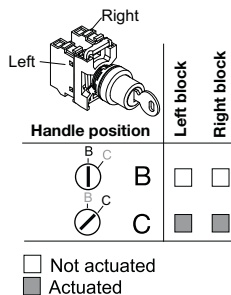

Three position key-operated selector switch

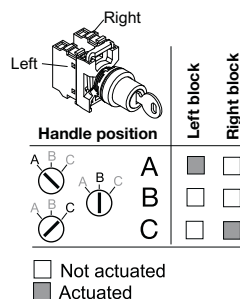

Contact blocks, holder and lamp block

See the fold-out page at the end of the catalog.

Bezel options

Description	How to order	Type	Order Code
Black plastic	Standard	MXSSKX-10X	1SFA61128X R100X
Chrome plastic	Replace '1' with '2' in Type and Order Code	MXSSKX-20X	1SFA61128X R200X
Chrome metal	Replace '1' with '3' in Type and Order Code	MXSSKX-30X	1SFA61128X R300X

Operator for key-operated selector switch

Symbol	The key can be removed in	Key code		Packing qty: 1 pc	Order Code	Weight, kg
		(71 = standard)	Ronis			

Two positions

Maintained

	in both positions	71	455	M2SSK1-101	1SFA 611 280 R1001	0.045
		72	421	M2SSK1-102	1SFA 611 280 R1002	0.045
		73	3433-E	M2SSK1-103	1SFA 611 280 R1003	0.045
		Other (on request)		M2SSK1-104	1SFA 611 280 R1004	0.045

Maintained

	in position B only	71	455	M2SSK2-101	1SFA 611 281 R1001	0.045
		72	421	M2SSK2-102	1SFA 611 281 R1002	0.045
		73	3433-E	M2SSK2-103	1SFA 611 281 R1003	0.045
		Other (on request)		M2SSK2-104	1SFA 611 281 R1004	0.045

Momentary, spring return from C to B

	in position B only	71	455	M2SSK3-101	1SFA 611 282 R1001	0.045
		72	421	M2SSK3-102	1SFA 611 282 R1002	0.045
		73	3433-E	M2SSK3-103	1SFA 611 282 R1003	0.045
		Other (on request)		M2SSK3-104	1SFA 611 282 R1004	0.045

Three positions

Maintained

	in all positions	71	455	M3SSK1-101	1SFA 611 283 R1001	0.045
		72	421	M3SSK1-102	1SFA 611 283 R1002	0.045
		73	3433-E	M3SSK1-103	1SFA 611 283 R1003	0.045
		Other (on request)		M3SSK1-104	1SFA 611 283 R1004	0.045

Maintained

	in position B only	71	455	M3SSK2-101	1SFA 611 284 R1001	0.045
		72	421	M3SSK2-102	1SFA 611 284 R1002	0.045
		73	3433-E	M3SSK2-103	1SFA 611 284 R1003	0.045
		Other (on request)		M3SSK2-104	1SFA 611 284 R1004	0.045

Momentary, spring return from A to B and from C to B

	in position B only	71	455	M3SSK3-101	1SFA 611 285 R1001	0.045
		72	421	M3SSK3-102	1SFA 611 285 R1002	0.045
		73	3433-E	M3SSK3-103	1SFA 611 285 R1003	0.045
		Other (on request)		M3SSK3-104	1SFA 611 285 R1004	0.045

Momentary, spring return from C to B

	in position A only	71	455	M3SSK4-101	1SFA 611 286 R1001	0.045
		72	421	M3SSK4-102	1SFA 611 286 R1002	0.045

Momentary, spring return from C to B

	in all positions	71	455	M3SSK5-101	1SFA 611 287 R1001	0.045
		72	421	M3SSK5-102	1SFA 611 287 R1002	0.045
		73	3433-E	M3SSK5-103	1SFA 611 287 R1003	0.045
		Other (on request)		M3SSK5-104	1SFA 611 287 R1004	0.045